

Pompe multistadio orizzontali monoblocco  
Horizontal multi-stage close coupled pumps  
Horizontale, mehrstufige Blockpumpen  
Pompes multicellulaires horizontales monobloc  
Bombas multicelulares horizontales monobloc  
Horizontal flersteps monoblock centrifugalpump  
Horizontale meertraps close-coupled pompen  
Οριζόντιες πολυβάθμιες κλειστού τύπου αντλίες  
Моноблочные горизонтальные многоступенчатые насосы  
卧式多级直联系

# MXP, MGP, MXA

**ISTRUZIONI ORIGINALI PER L'USO**  
**OPERATING INSTRUCTIONS**  
**BETRIEBSANLEITUNG**  
**INSTRUCTIONS POUR L'UTILISATION**  
**INSTRUCCIONES DE USO**  
**DRIFT/INSTALLATIONSANVISNINGAR**  
**BEDIENINGSVOORSCHRIFT**  
**ΟΔΗΓΙΕΣ ΧΕΙΡΙΣΜΟΥ**  
**Инструкции по эксплуатации**  
安装使用手册

Pagina	2	Italiano
Page	8	English
Seite	14	Deutsch
Page	20	Français
Página	26	Español
Sidan	32	Svenska
Pagina	38	Nederlands
Σελίδα	44	Ελληνικά
Стр.	50	Русский
页码	56	中文

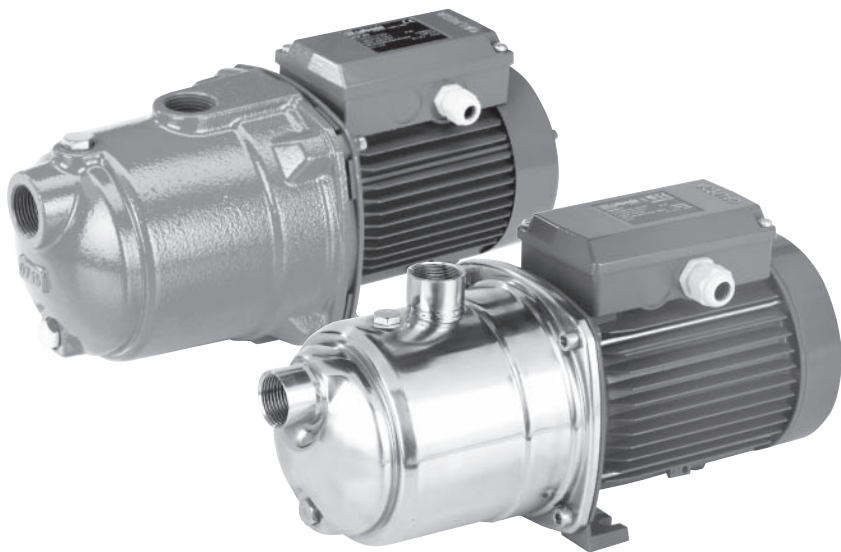

SUMMARY

1. GENERAL INFORMATION.....	8
2. TECHNICAL DESCRIPTION.....	9
3. TECHNICAL FEATURES.....	9
4. SAFETY.....	9
5. TRANSPORTATION AND HANDLING.....	10
6. INSTALLATION.....	10
7. STARTUP AND OPERATION.....	11
8. MAINTENANCE.....	12
9. DISPOSAL.....	12
10. SPARE PARTS.....	12
11. ESIGNATION OF PARTS.....	12
12. TROUBLESHOOTING.....	13
Installation examples.....	61
Drawing for dismantling and assembly.....	62
Declaration of conformity.....	64

1. GENERAL INFORMATION

Before using the product carefully read the information contained in this instruction manual, the manual should be kept for future reference.

Italian is the original language of this instruction manual, this language is the reference language in case of discrepancies in the translations.

This manual is part of the essential safety requirement and must be retained until the product is finally decommissioned.

The customer, in case of loss, can request a copy of the manual by contacting Calpeda S.p.A. or their agent, specifying the type of product data shown on the label of the machine (see 2.3 Marking)

Any changes, alterations or modifications made to the product or part of it, not authorized by the manufacturer, will revoke the "CE declaration" and warranty.

This appliance should not be operated by children younger than 8 years, people with reduced physical, sensory or mental capacities, or inexperienced people who are not familiar with the product, unless they are given close supervision or instructions on how to use it safely and are made aware by a responsible person of the dangers its use might entail.

Children must not play with the appliance.

It is the user's responsibility to clean and maintain the appliance. Children should never clean or maintain it unless they are given supervision.

Do not use in ponds, tanks or swimming pools or where people may enter or come into contact with the water.

Read carefully the installation

section which sets forth:

- The maximum permissible structural working pressure (chapter 3.1).
- The type and section of the power cable (chapter 6.5).
- The type of electrical protection to be installed (chapter 6.5).

1.1. Symbols

To improve the understanding of the manual, below are indicated the symbols used with the related meaning.



Information and warnings that must be observed, otherwise there is a risk that the machine could damage or compromise personnel safety.



The failure to observe electrical information and warnings, could damage the machine or compromise personnel safety.



Notes and warnings for the correct management of the machine and its parts.



Operations that could be performed by the final user. After carefully reading of the instructions, is responsible for maintenance under normal conditions. They are authorized to affect standard maintenance operations.



Operations that must be performed by a qualified electrician. Specialized technician authorised to affect all electrical operations including maintenance. They are able to operate with in the presence of high voltages.



Operations that must be done performed by a qualified technician. Specialized technician able to install the device, under normal conditions, working during "maintenance", and allowed to do electrical and mechanical interventions for maintenance. They must be capable of executing simple electrical and mechanical operations related to the maintenance of the device.



Indicates that it is mandatory to use individual protection devices.



Operations that must be done with the device switched off and disconnected from the power supply.



Operations that must be done with the device switched on.

1.2. Manufacturer name and address

Manufacturer name: Calpeda S.p.A.  
Address: Via Roggia di Mezzo, 39  
36050 Montorso Vicentino - Vicenza / Italia  
www.calpeda.it

1.3. Authorized operators

The product is intended for use by expert operators divided into end users and specialized technicians. (see the symbols above).



It's forbidden, for the end user, carry out operations which must be done only by specialized technicians. The manufacturer declines any liability for damage related to the non-compliance of this warning.

## 1.4. Warranty

For the product warranty refer to the general terms and conditions of sale.



The warranty covers only the replacement and the repair of the defective parts of the goods (recognized by the manufacturer).

The Warranty will not be considered in the following cases:

- Whenever the use of the device does not conform to the instructions and information described in this manual.
- In case of changes or variations made without authorization of the manufacturer.
- In case of technical interventions executed by a non-authorized personnel.
- In case of failing to carry out adequate maintenance.

## 1.5. Technical assistance

Any further information about the documentation, technical assistance and spare parts, shall be requested from: Calpeda S.p.A. (paragraph 1.2).

## 2. TECHNICAL DESCRIPTION

Horizontal Multi-Stage Close Coupled Pumps (self-priming pumps MXA-series).

MXP: version with pump casing in AISI 304 with impeller PPO-GF20.

MGP: version with pump casing in Cast iron with impeller PPO-GF20.

MXA: version with pump casing in AISI 304 with impeller PPO-GF20.

### 2.1. Intended use

For clean liquids: non-explosive and non-flammable, non-hazardous for health or the environment, non-aggressive for pump materials, not containing abrasives, solid or fibrous particles.

Liquid temperature from - 0 °C to + 50 °C (from 0 °C to + 35 °C for MXA).

### 2.2. Improper use

The device is designed and built only for the purpose described in paragraph 2.1.



Improper use of the device is forbidden, as is use under conditions other than those indicated in these instructions.

Improper use of the product reduces the safety and the efficiency of the device, Calpeda shall not be responsible for failure or accident due to improper use.



Do not use in ponds, tanks or swimming pools or where people may enter or come into contact with the water.

### 2.3. Marking

The following picture is a copy of the name-plate that is on the external case of the pump.

	Example plate pump	
1 Pump type		- 16
2 Delivery		
3 Head		
4 Rated power		
5 Tension nominale		
6 Nom. motor current		
7 Notes		
8 Fréquence		
9 Operation Duty		
10 Insulation class		
11 Weight		
12 Power factor		
13 Rotation speed rpm		
14 Protection		
15 Serial number		
16 Certifications		

## 3. TECHNICAL FEATURES

### 3.1. Technical data

Dimensions and weight (see technical catalogue).

Nominal speed 2900/3450 rpm

Protection IP54

Supply voltage / Frequency:

- up to 240V 1~ 50/60 Hz

- up to 480V 3~ 50/60 Hz

Check that the mains frequency and voltage correspond to the electrical characteristics shown on the indicator plate.

The electric data marked on the label are referred to the nominal power of the motor.

Sound pressure: < 70 dB (A).

Max. starts per hour: 15 at regular intervals.

Maximum permissible pressure in the pump casing: 80 m (8 bar).

### 3.2. Operating conditions

Installation in well ventilated location protected from the weather, with a maximum ambient temperature of 40 °C.

## 4. SAFETY

### 4.1. General provisions

Before using the product it is necessary to know all the safety indications.



Carefully read all operating instructions and the indications defined for the different steps: from transportation to disposal.

The specialized technicians must carefully comply with all applicable standards and laws, including local regulations of the country where the pump is sold.

The device has been built in conformity with the current safety laws. The improper use could damage people, animals and objects.

The manufacturer declines any liability in the event of damage due to improper use or use under conditions other than those indicated on the name-plate and in these instructions.



Follow the routine maintenance schedules and the promptly replace damaged parts, this will allow the device to work in the best conditions.

Use only original spare parts provided from Calpeda S.p.A or from an authorized distributor.



Don't remove or change the labels placed on the device.

Do not start the device in case of defects or damaged parts.



Maintenance operations, requiring full or partial disassembly of the device, must be done only after disconnection from the supply.

### 4.2. Safety devices

The device has an external case that prevents any contact with internal parts.

### 4.3. Residual risks

The appliance, designed for use, when used in-line with the design and safety rules, doesn't have residual risks.

### 4.4. Information and Safety signals

For this kind of product there will not be any signals on the product.

## 4.5. Individual protection devices

During installation, starting and maintenance it is suggested to the authorized operators to consider the use of individual protection devices suitable for described activities.

During ordinary and extraordinary maintenance interventions, safety gloves are required.

Signal



individual protection device  
**HAND PROTECTION**  
(gloves for protection against chemical, thermal and mechanical risks).

## 5. TRANSPORTATION AND HANDLING

The product is packed to maintain the content intact. During transportation avoid to stack excessive weights. Ensure that during the transportation the box cannot move.

It is not necessary to use any special vehicle to transport the packaged device.

The transport vehicles must comply, for the weight and dimensions, with the chosen product (see technical catalogue dimensions and weights).

### 5.1. Handling

Handle with care, the packages must not receive impacts.

Avoid to impact onto the package materials that could damage the pump.

If the weight exceeds 25 Kg the package must be handled by two person at the same time.

## 6. INSTALLATION

### 6.1. Dimensions

For the dimensions of the device (see technical catalogue).

### 6.2. Ambient requirements and installation site dimensions

The customer has to prepare the installation site in order to guarantee the right installation and in order to fulfill the device requirements (electrical supply, etc...). The place where the device will be installed must fulfill the requirements in the paragraph 3.2.

It's Absolutely forbidden to install the machine in an environment with potentially explosive atmosphere.

### 6.3. Unpacking



Inspect the device in order to check any damages which may have occurred during transportation.

Package material, once removed, must be discarded/recycled according to local laws of the destination country.

### 6.4. Installation

See installation examples, par. 13 fig. 1 and 2.

The pumps must be installed with the rotor axis in the horizontal position and with the feet under the pump. Place the pump as close as possible to the suction source.

Provide space around the pump for motor ventilation, to allow for checking of shaft rotation, for filling and draining the pump and to allow for collection of the liquid to be removed.

### 6.4.1. Pipes

Ensure the insides of pipes are clean and unobstructed before connection.

**ATTENTION: The pipes connected to the pump should be secured to rest clamps so that they do not transmit stress, strain or vibrations to the pump (par. 13 fig. 3).**

Tighten the pipes or union coupling to the extent sufficient to ensure a tight seal (par. 13 fig. 6).

Excessive torque may cause damage to the pump. When the pipe or union coupling is mounted, keep the pump casing connection blocked with a second wrench, making sure the connection is not deformed by excessive tightening.

The pipe diameters must not be smaller than the pump connections.

### 6.4.2. Suction pipe

If the suction pipe is longer than 10 m, use an internal pipe diameter larger than the pump suction connection. For capacities over 4 m<sup>3</sup>/h use a suction pipe G 1 1/4 (DN 32).

The suction pipe must be perfectly airtight and be led upwards in order to avoid air pockets.

With a pump located above the water level (suction lift operation, par. 13, fig. 2) fit a foot valve with strainer which must always remain immersed (or a check valve on the suction connection for MXA).

If operating with flexible hoses use a reinforced spiral suction hose, in order to avoid the hose narrowing due to suction vacuum.

With the liquid level on the suction side above the pump (inflow under positive suction head, par. 13, fig. 1) fit an inlet gate valve.

For suction from a storage tank fit an anti-backflow valve. Follow local specifications if increasing network pressure.

Install a strainer on the suction side of the pump to prevent foreign particles from entering the pump.

### 6.4.3. Delivery pipe

Fit a gate valve in the delivery pipe to adjust delivery and head.

Install a pressure gauge.

With a geodetic head at outlet over 15 m fit a check valve between the pump and the gate valve in order to protect the pump from water hammering.

## 6.5. Electrical connection



Electrical connection must be carried out only by a qualified electrician in accordance with local regulations.

### Follow all safety standards.

**The unit must be properly earthed (grounded).**

Connect the earthing (grounding) conductor to the terminal with the ⊕ marking.

Compare the frequency and mains voltage with the name-plate data and connect the supply conductors to the terminals in accordance with the appropriate diagram inside the terminal box cover.



**ATTENTION: never allow washers or other metal parts to fall into the internal cable opening between the terminal box and stator.** If this occurs, dismantle the motor to recover the object which has fallen inside.

If the terminal box is provided with an inlet gland, use a flexible power supply cord of the H07 RN-F type with section of cable not less than (par. 13.2 TAB 1).

If the terminal box is provided with an inlet bushing,

connect the power supply cord through a conduit. For use in swimming pools (not when persons are in the pool), garden ponds and similar places, a **residual current device** with I $\Delta$ N not exceeding 30 mA must be installed in the supply circuit.

Install a **device for disconnection from the mains** (switch) with a contact separation of at least 3 mm in all poles.

With a three-phase motor install an overload protection device with curve D appropriate for the rated current of the pump.

Single-phase, are supplied with a capacitor connected to the terminals and (for 220-240 V - 50 Hz) with an incorporated thermal protector.



**ATTENTION:** When the pump is fed by a frequency converter, the minimum frequency should not fall below 25Hz and in any case the total head of the pump should never be lower than 3 m.

## 7. STARTUP AND OPERATION

### 7.1. Preliminary checks before start-up of the pump

Do not start-up the device in case of damaged parts.

### 7.2. First starting



**ATTENTION: never run the pump dry.** Start the pump after filling it completely with liquid.

**When the pump is located above the water level** (suction lift operation par. 13 fig. 2) or with a positive suction head which is too low (less than 1 m) to open the non-return valve, fill the pump through the priming hole (par. 13 fig. 4).

**When the liquid level on the suction side is above the pump** (inflow under positive suction head par. 13 fig. 1), fill the pump by opening the suction gate valve slowly and completely, keeping the delivery gate valve open to release the air.

Before starting, check that the shaft turns by hand. For this purpose use the screwdriver notch on the shaft end on the ventilation side.

**When starting, with a three-phase motor, check that the direction of rotation** is as shown by the arrows on the lantern bracket.

Otherwise, disconnect electrical power and reverse the connections of two phases.

Check that the pump works within its field of performance and that the absorbed current shown on the name-plate is not exceeded. Otherwise adjust the delivery gate valve or the setting of any pressure switches.

If a priming loss occurs (interruption of delivery flow) or if a pressure oscillation is indicated by the pressure gauge, make sure all the suction pipe couplings are perfectly sealed and tighten the two sealed plugs on the pump casing.



**Never run the pump for more than five minutes with a closed gate valve.**

Prolonged operation without a change of water in the pump causes dangerous increases of temperature and pressure.

When the water is overheated due to prolonged operation with a closed port, stop the pump before opening the gate valve.

To avoid any risk of danger to users and the creation of harmful thermal stress in the pump and system due to large temperature differentials, wait until the water has

cooled inside the pump before starting again.

If the water is overheated on account of prolonged operation with a non-primed or insufficiently filled pump (suction lift operation), wait until cool before opening the draining and filling plugs.



**Care must be taken when the pumped fluid has a high temperature. Do not touch the fluid when its temperature is higher than 60 °C. Do not touch the pump when the surface temperature is higher than 80 °C.**

GB

### 7.3. Automatic regulator IDROMAT

(can be supplied on request)

For automatic control of starting/stopping of the pump when utilization points are opened/closed.

For protection of the pump:

- against dry running;
  - against the risk of operation without water at the inlet (caused by a lack of water inflow in the inlet pipe under positive suction head, by a non-immersed suction pipe, by excessive suction lift or by air entering the suction pipe);
  - against operation with closed connection ports.
- See installation examples par. 13 fig. 1, fig. 2.

### 7.4. Self-priming (Only for MXA)

(Capability to clear the air in the suction pipe when starting with the pump located above the water level).

**Conditions for self-priming:**

- suction pipe with connections perfectly airtight and properly immersed in the water to be lifted;
- discharge pipe with a straight vertical free line above discharge port, before a non-return valve par. 13 fig. 1.
- **pump casing completely filled with clean cold water before starting.**

The pump is not self-priming with liquids containing oil, alcohol or foaming substances.

The check valve (par. 13 fig. 1) prevents reverse siphoning through the pump when the pump is stopped and retains water in the pump for the next start.

**Without a foot valve or a check valve on the suction connection the filling operation must be repeated before each start-up.**



**ATTENTION: avoid a prolonged operation with unprimed pump, without water delivery from the completely opened outlet. If the pump does not prime in 5 minutes: stop the motor, remove the priming plug and add more water.**

If necessary, repeat the priming operation after the pump has been first emptied and then completely filled with clean cold water.

### 7.5. Switch off of the pump



The appliance must be switch off every time there are faults. (see troubleshooting).

The product is designed for a continuous duty, the switch off is performed by disconnecting the power supply by means the expected disconnecting devices. (see paragraph "6.5 Electrical connection").

## 8. MAINTENANCE

Before any operations it's necessary to disconnect the power supply.

If required ask to an electrician or to an expert technician.





Every maintenance operations, cleaning or repairation executed with the electrical system under voltage, it could cause serious injuries to people.



If the supply cord is damaged, it must be replaced by the manufacturer, its service agent or similarly qualified persons in order to avoid a hazard.

In case of extraordinary maintenance, or maintenance operations that require part-removing, the operator must be a qualified technician able to read schemes and drawings.

It is suggest to register all maintenance operation executed.



During maintenance keep particular attention in order to avoid the introduction of small external parts, that could compromise the device safety.



It is forbidden to execute any operations with the direct use of hands. Use water-resistant, anti-cut gloves to disassemble and clean the filter or in other particular cases.



During maintenance operations external personnel is not allowed.

Maintenance operations that are not described in this manual must be made only by special personnel authorized by Calpeda S.p.A.

For further technical information regarding the use or the maintenance of the device, contact Calpeda S.p.A.

### 8.1. Routine maintenance



Before every maintenance operations disconnect the power supply and make sure that the device could not accidentally operate.



In the case of water containing chloride (chlorine, sea water), the risk of corrosion increases in stagnant water condicions (also with an increase in temperature and decrease of pH value). In these cases, **if the pump remains inactive for long periods, it must be emptied completely and, preferably, dried.**



For good measure, as in the case of **temporary operation with dirty liquids**, run the pump briefly with clean water to remove deposits.

**When the pump remains inactive it must be emptied completely if there is a risk of freezing** (par. 13 fig. 5).

Before restarting the unit, check that the shaft is not jammed and fill the pump casing completely with liquid.

### 8.2. Dismantling the system

Close the suction and delivery gate valves and drain the pump casing before dismantling the pump.

### 8.3. Dismantling the pump



Close the suction and delivery gate valves and drain the pump casing before dismantling the pump (par. 13 fig. 5).

For dismantling and re-assembly see construction in the cross section drawing.

## 9. DISPOSAL

OFF



The final disposal of the device must be done by specialized company.

Make sure the specialized company follows the classification of the material parts for the separation. Observe the local regulations and dispose the device accordingly with the international rules for environment protection.

## 10. SPARE PARTS

### 10.1. Spare-parts request

When ordering spare parts, please quote their designation, position number in the cross section drawing and rated data from the pump name plate (type, date and serial number).

The spare parts request shall be sent to CALPEDA S.p.A. by phone, fax, e-mail.

## 11. ESIGNATION OF PARTS

Nr.	Designation
14.00	Pump casing
14.04	Plug
14.06	O-ring
14.12	Plug
14.16	O-ring
14.20	O-ring
14.24	Screw
16.00	Suction casing
16.14	Plunger
16.15	Spring
16.16	O-ring
16.17	Valve
20.00	Delivery casing
22.12	O-ring
22.16	O-ring
25.01	First stage casing
25.02	Stage casing (complete)
25.05	Last stage casing
25.10	Washer for missing impeller
25.11	First stage spacer
28.00	Impeller
28.04	Impeller nut
28.08	Washer
34.00	Casing cover
36.00	Mechanical seal
36.51	Retaining ring, split
36.52	Shoulder ring
46.00	Deflector
64.15	Spacer sleeve
70.00	Lantern bracket
73.00	Ball bearing
76.00	Motor casing with winding
76.04	Cable gland
76.16	Support
76.20	Pin
76.54	Terminal box, set
78.00	Shaft with rotor packet
81.00	Ball bearing
82.00	Motor end shield
82.04	Compensating spring
88.00	Motor fan
90.00	Fan cover
90.04	Screw
92.00	Tie-bolt
94.00	Capacitor
98.00	Terminal box cover
98.08	Gasket

Changes reserved.

## 12. TROUBLESHOOTING



**WARNING:** Turn off the power supply before performing any operations.

Do not allow the pump or motor to run when dry even for a short period.

Strictly follow the user instructions and if necessary contact an authorised service centre.

PROBLEM	PROBABLE CAUSES	POSSIBLE REMEDIES
1) The motor does not start	1a) Unsuitable power supply 1b) Incorrect electrical connections 1c) Engine overload protective device cuts in. 1d) Blown or defective fuses 1e) Shaft blocked 1f) If the above causes have already been checked, the engine may be malfunctioning	1a) Check that the mains frequency and voltage correspond to the electrical characteristics shown on the indicator plate 1b) Connect the power supply cable to the terminal board correctly. Check that the thermal overload protection is set correctly (see data on the engine indicator plate) and make sure that the fuseboard upline of the engine has been properly connected 1c) Check the power supply and make sure that the pump shaft is turning freely. Check that the thermal overload protection has been set correctly (see engine indicator plate) 1d) Replace the fuses, check the electric power supply and points a) and c) 1e) Remove the cause of blockage as indicated in the "Blocked pump" instruction booklet 1f) Repair or replace the engine by applying to an authorised service centre
2) Pump blocked	2a) Prolonged periods of inactivity with formation of rust inside the pump 2b) Presence of solid bodies in the pump rotor 2c) Bearings siezed	2a) Rotation may be started directly from the pump shaft or from the joint (remember to turn off the electricity supply first ) or contact an authorised service centre 2b) If possible, dismantle the pump casing and remove any solid foreign bodies inside the rotor, if necessary contact an authorised service centre 2c) If the bearings are damaged replace them or if necessary contact an authorised service centre
3) The pump functions but no water comes out	3a) Possible infiltration of air from suction tube connections, drain plugs or filling of pump or from the gaskets of the suction pipe 3b) Foot valve blocked or suction pipe not fully immersed in liquid 3c) Suction filter blocked	3a) Check which part is not tight and seal the connection adequately 3b) Clean or replace the bottom valve and use a suction pipe suitable for the application 3c) Clean the filter, if necessary, replace it . See point 2a) also.
4) Insufficient flow	4a) Pipes and accessories with diameter too small causing excessive loss of head 4b) Presence of deposits or solid bodies in the internal passages of the rotor 4c) Rotor deteriorated 4d) Worn rotor and pump case 4e) Excessive viscosity of the liquid pumped (if other than water) 4f) Incorrect direction of rotation 4g) Suction head excessive in relation to the suction capacity of pump 4h) Suction pipe too long	4a) Use pipes and accessories suitable for the specific application 4b) Clean the rotor and install a suction filter to prevent other foreign bodies from entering 4c) Replace the rotor, if necessary, contact an authorised service centre 4d) Replace the rotor and the pump casing 4e) The pump is unsuitable 4f) Invert the electrical connections on the terminal board or control panel 4g) Try to close the feeder gate partially and/or reduce the difference in level of the pump and the liquid being aspirated 4h) Bring the pump closer to the suction tank so as to use a shorter pipe. If necessary use a pipe of a wider diameter
5) Noise and vibrations from the pump	5a) Rotating part unbalanced 5b) Worn bearings 5c) Pump and pipes not firmly attached 5d) Flow too strong for the diameter of the delivery pipe 5e) Functioning in cavitation 5f) Unbalanced power supply 5g) Incorrect alignment of pump-motor unit	5a) Check that no solid bodies are obstructing the rotor 5b) Replace the bearings 5c) Anchor the delivery and suction piping as needed 5d) Use bigger diameters or reduce the pump flow 5e) Reduce the flow by adjusting the feeder gate and/or using pipes with a bigger internal diameter. See point 4g) too 5f) Check that the mains voltage is right 5g) If necessary, the unit must be re-aligned
6) Leakage from the mechanical seal	6a) The mechanical seal has functioned when dry or has stuck 6b) Mechanical seal scored by presence of abrasive parts in the liquid pumped 6c) Mechanical seal unsuitable for the type of application 6d) Slight initial drip during filling or on first start-up	In cases 6a), 6b) and 6c), replace the seal, if necessary contact an authorised service centre 6a) Make sure that the pump casing (and the suction pipe if the pump is not self-priming) are full of liquid and that all the air has been expelled. See point 5 e) too. 6b) Install a suction filter and use a seal suited to the characteristics of the liquid being pumped. 6c) Choose a seal with characteristics suitable for the specific application 6d) Wait for the seal to adjust to the rotation of the shaft. If the problem persists, see points 6a), 6b) or 6c) or contact an authorised service centre.

本操作手册属CALPEDA S.P.A.所有，禁止任何形式的复制，即使是部分的。

摘要	
1. 总则	56
2. 技术说明	56
3. 技术特性	57
4. 安全性	57
5. 搬运操作	57
6. 安装	57
7. 启动和运行	58
8. 维修	59
9. 处理	59
10. 备件	59
11. 部件名称	59
12. 常见故障和解决方法	60
安装示意图	61
组装与分解图	62
声明	64

## 1. 总则

中文

使用本产品前请仔细阅读此操作手册的内容，并保留此操作手册以供参考。  
 此操作手册为意大利语，如有翻译偏差以意大利语为准。  
 此操作手册是安全保障必不可少的一部分，在产品最终达到正常工作前请牢记本手册。  
 万一用户不慎遗失本手册，可向CALPEDA S.P.A.或其代理商要求一份复印件，请详述产品铭牌上的资料（见2.3 标记）  
 未经制造商认可的有关其产品或部件的任何更改变化，将撤消“CE 声明”和质保。

此产品不应让8岁以下的未成年、身体有缺陷、心智不全或无任何经验的人操作，除非在充分的指导或监督下让相关人员知道如何安全的使用，并且通过一个负责人来让相关人员了解到可能会产生的危险。

不得让儿童接触本产品。  
 用户有义务清洁和维护本产品。  
 除非在有人监督的情况下，否则儿童不应清洁和维护本产品。  
 不要使用在池塘、水箱或泳池等人为可以进入或接触的水环境中。  
 仔细阅读安装部分的规定：  
 -最大允许的结构工作压力详见3.1  
 -电源线的类型及剖面详见6.5  
 -所安装电器设备的防护类型详见6.5

### 1.1. 符号标记

为了便于理解本操作手册，下面给出常用标记符号的含义。



 一定要注意警告和警告的标记，否则可能导致产品损坏或人身安全的风险。

 忽略有关电气的警告，可能导致产品损坏或人身安全的风险

 提示和警告正确操作处理产品及其部件

 最终用户可以进行的操作  
 终端用户：仔细阅读本操作手册后，产品使用者可以负责正常状态下的维护工作。他们可以对其进行产品的清洁和长期停滞后的重新启动此类标准维护工作。

 必须由有资格的专业电工才能进行的操作  
 专业电工：有资格的专业电工，负责所有电气设备的运行包括维护，应具有高压电资格。

 必须由有专业技术资格的人才能进行的操作  
 专业技术人员：正常状态下，具有产品安装和维护能力的专业技术人员，可以从事电气和机械方面的维护工作。能够从事简单的与设备维护相关的电气和机械方面的操作。  
 指示必须使用个别的保护装置

 必须关断电源并断开与电源的连接才能进行的操作

 必须接通电源才能进行的操作

### 1.2. 制造商名称和地址

制造商名称：CALPEDA S.P.A.  
 地址：Via Roggia di Mezzo, 39  
 36050 Montorso Vicentino - Vicenza / Italia  
[www.calpeda.it](http://www.calpeda.it)

### 1.3. 授权操作者

本产品只能由有经验的终端用户和专业技术人员操作  
 禁止终端用户操作那些只能由专业技术人员操作的工作，对未按本规章执行而引起的损害制造商不负任何责任

### 1.4. 质保

质保参见总则和销售条款  
 质保期内将更换或维修有问题的产品部件（由制造商验证的）。

下面因素不在质保范围：  
 - 由于产品使用者没有按照说明及本手册的通告信息操作造成的损坏  
 - 未经制造商认可的对产品的任何改变而造成的损坏  
 - 由非专业人员操作造成的损坏  
 - 由不当的维修造成的损坏

### 1.5. 技术支持

任何技术支持、备件及更多的产品信息均可联系：Calpeda S.p.A. (附件1.2章)。

## 2. 技术说明

不锈钢卧式多级直联泵  
 MXP：泵壳和为AlSi304不锈钢叶轮PPO-GF20  
 MGP：泵壳和为铸铁叶轮PPO-GF20  
 MXA：泵壳和为AlSi304不锈钢叶轮PPO-GF20



## 2.1. 预期用途

适用于清洁的介质：不含易燃易爆、对健康或环境有害、对泵材质有腐蚀性的介质，不含有研磨性、固体颗粒及纤维状物质的介质。

液体温度从0°C到+50°C (0°C到+35°C MXA)。

## 2.2. 不当使用

本产品只用于2.1中所述用途

除了本说明手册中指示的用途外，严禁其他不当用途

不当使用将降低本产品的安全性和效率，由于不当使用而造成的损坏和意外，CALPEDA不承担责任

严禁用于可能有人员进入或与水接触的池塘、水箱或游泳池

## 2.3. 标记

下面给出的是泵外壳上的标牌的图片

	泵标牌图示		
1 型号		16	
2 流量		1- XXXXXXXX	15
3 扬程		2- Q min/max. X/X m³/h	
4 额定功率		3- H max/min. X/X m	14
5 电源电压		4- X kW (X hp) S.F. IP XX	13
6 电流		5- 220Δ/380Y V3-50Hz n XXXX/min	12
7 注释		6- X/X A S1 I.ct. X X kg	11
8 频率		7- XXXXXXXX	
9 运行工作制			
10 绝缘等级			
11 重量			
12 功率因数			
13 转速rpm			
14 保护等级			
15 序列号			
16 认证			

## 3. 技术特性

### 3.1. 技术参数

尺寸和重量 (详见产品样本)

额定转速 2900/3450rpm

保护等级 IP54

电压/频率: - 高达 240V 1~ 50/60 Hz

- 高达 480V 3~ 50/60 Hz

检查主电源的电压、频率等参数是否符合电机铭牌所示标牌的电气数据依据电机的正常功率而标出。

噪声等级 < 70 dB (A)

每小时最大启动次数：时间间隔相同的情况下可启动15次

泵壳允许最大压力：80 m (8 bar)。

## 4. 安全性

### 4.1. 总则

使用本产品前应了解有关安全的指示  
仔细阅读所有的操作说明和从搬运到处理的每一步指示专业技术人员必须认真遵从所有的适用标准和法律，包括产品应用地当地的规章

产品安装使用应符合现行的安全法规

不当的使用可能会对人身、动物和其他对象造成损害  
制造商对由于不当使用或未按本操作手册和标牌的标示使用所造成的损坏不负责任

按照日程维护计划表操作并及时更换损坏的部件可使产品工作在最佳状态

使用CALPEDA S.P.A或其指定代理商提供的原厂配件

不要撕下或改变产品上的标识  
当产品有问题或部件有损坏的情况下不要启动产品

由于维修时会全部或部分的拆开产品，因此之前务必断开供电电源



## 4.2. 安全装置

本产品具有全外部壳体，可防止与内部部件的任何接触

## 4.3. 剩余风险

当按照本产品的设计功能和所有安全规则使用本产品时没有剩余风险

## 4.4. 通告和安全警示

没有任何安全警示在此类产品上面

## 4.5. 个别的保护装置

在安装、使用和维修期间，建议操作人员使用适合此操作的个别保护装置或手段当进行日常或个别的维修工作时

标示的个别保护装置

手的保护  
(防热、化学品和机械损害的手套)

## 5. 搬运操作

货物应包装完好

运输过程中应避免超重，并确保货物不会移动。确保运输车辆和所运货物尺寸相符合

无需特殊车辆运输  
运输车辆应与被运货物的尺寸重量相符合(尺寸和重量详见产品样本)。

### 5.1. 搬运

小心搬运，轻拿轻放

避免冲撞包装材料以免损坏泵的外套

对于重量超过25公斤的包装物需由两人同时抬抬

## 6. 安装

### 6.1. 尺寸

设备的外形尺寸 (详见产品样本)

### 6.2. 环境要求和安装位置的尺寸

客户应将本产品妥当的安装于适当位置以满足设备的要求 (供电需要等)

安装位置应满足章节3.2中的要求

禁止将产品安装于有潜在易燃易爆危险的环境中

### 6.3. 拆箱

开箱检查产品是否因运输而损坏



拆开的包装材料应根据产品使用国当地的法律规定废弃或再利用

### 6.4. 安装

参见安装示例13 图1和图2

在安装时，务必将水泵沿泵转子轴线方向水平放置且底部应在泵下方。

泵的位置应尽可能接近水源

应预留出一定的空间以满足电机的通风要求、检查轴的转向、灌泵及排水、及排水的收集移除

#### 6.4.1. 管道

应确保连接前所有管道内部干净、无堵塞；

注意：管道与水泵的连接应当支撑可靠，并紧固联接，以确保不传递应力应变及振动到泵上章13,图3.

应拧紧管道和连接接头，确保必要的密封章13,图6

过大的扭矩可能损伤水泵

当连接管道与接头时，应当用其它扳手锁住泵壳

以确保过多的应力不作用到泵体上  
管子直径绝不能小于泵的联接口的直径。

#### 6.4.2. 吸入管

如果入口管路长度大于10m，则使用的管路内径应大于吸入口连接端。

当流量大于4M<sup>3</sup>/H时，应使用 G1 1/4 (DN32) 的管路。

务必保证管路的气密性并且将管路倾斜向上以避免气泡的影响。

当泵在液面上方时（吸上水头为负，图2）应安装一带过滤器的底阀且必须保持完全浸没。

如果使用软管，则应使用增强螺旋管，以避免软管被泵吸瘪。

当介质液面在泵入口之上时（吸上水头为正，图1）应安装一个配套的闸阀。

从水箱吸水时应安装在入口和水箱间安装一个止回阀。

增加管网压力需根据当地规则要求。

在泵入口侧安装一个过滤器以防止异物进入到泵内。

#### 6.4.3. 出水管

在出水管中安装一闸阀，以调节流量，扬程和轴功率。

一定要安装压力表。

当静压力水头大于15m时，应在泵与闸阀间安装一个止回阀，以防止水锤对泵的损害。

#### 6.5. 电气联接



必须由合格电工根据当地规范进行电气联接。  
必须遵守安全标准。

泵-电机机组必须可靠地接地。

把接地导线接到标有记号的端子上 ⊕。

请对照电源电压和铭牌上所标数值，根据接线盒内盖上的电路图联接电源。

注意：绝对不允许将垫片等金属部件掉入电机接线盒的定子线圈中。

如果发生此种问题，必须拆开电机，取出部件。

如果接线盒的进线口为密封管，则应使用H07RN-F型柔软的电线电缆的剖面不低于表(章13.2)的相关规定。

作为用于游泳池，花园池塘的泵，必须在电源线路中安装漏电保护器，其灵敏度不大于30毫安。

注意：绝对不允许将垫片等金属部件掉入电机接线盒的定子线圈中。

如果发生此种问题，必须拆开电机，取出部件。

安装一个使电源断开的装置，各电极之间至少有3mm的间隙。

对于三相电机，根据其额定电流一定要安装一个过载保护装置。

对于单相的泵，提供一个连接在接线柱上的电容，对于220-240V-50Hz的电源，还提供一个相连的热保护装置。

注意：当泵由变频器控制的时候，频率不允许低于25Hz并且水泵总扬程在任何情况下都不能低于3m

## 7. 启动和运行

### 7.1. 启动前的预检

当存在有故障的部件时不要启动本产品

### 7.2. 首次启动



请注意：千万不要使泵干态运行。

一定先注水后再启动泵。

当泵位置高于水面(吸上扬程为负章13,图3)时,或者正压头大小(小于1m)不足以打开止回阀,应通过自吸孔注水(章13,图,4)

当泵位置低于水面(吸上水头为正,章13,图.1),慢慢打开吸入端闸阀,直到完全打开,以此对泵注水,这时应确保出水端的闸阀处于打开状态以排除空气。

启动前,应手工检查轴的自由度,方法是:

在电机侧用螺丝刀旋转轴端即可。

对于三相电机,要检查旋转方向是否如泵盖上的箭头方向所示;否则,切断电源,并改变其中两相的联接。

确认泵工作在其性能参数范围内,实际的工作电流不能超过铭牌上标注的电流值。否则应调整出口阀门开度或压力开关的设置。

如果吸不上水(不出水)或者压力表显示压力波动,应检查并确保所有的入口管路连接气密性完好并保证泵壳上的加/排水堵密封完好。

永远不要让泵闲闭运行超过5分钟



泵中的水长期的憋压运行会导致温度和压力升高的危险。

长时间的憋压运行会导致泵中的水过热,打开闸阀前应先停泵。

为了避免对用户产生危害以及避免因较大的温差使泵和系统中产生的有害的热应力,应等到泵内水冷却下来才可再次启动。

如果因为没灌或灌泵不充分(自吸运行)而导致水过热,应待其冷却后再打开加/排水堵头。

当泵送高温介质时应特别注意。当介质温度高于60 °C时不要接触介质,当泵表面温度高于80 °C时不要接触泵设备。



### 7.3. 自动调节器(IDROMAT)

(可按要求提供)

当用水点打开/关闭时可以自动控制泵的起/停。

对泵起保护作用

·防止干转。

·防止无进水时工作(实际吸程过大,吸水管未浸入水中,过大的吸入损失,吸水管内有空气)。

·防止管路连接端口关闭。

(见安装示意图1、2)。

### 7.4. 自吸 (MXA只有)

(意思是当泵工作在排吸入的水平面上方时,排除吸入管内空气的能力)。

自吸的条件

·吸水管必须连接完好并具有良好的气密性且要完全浸入水中。

·排水管在泵的出口至止回阀之前必须有一段垂直向上的管路(见图1)。

·启动之前应用洁净的冷水将泵完全灌满。

·当介质为含油、酒精、泡沫物质时泵不能自吸。

·当泵停止工作时,单向阀(见图1)可以防止水的回流产生虹吸,并将水留在泵内方便下次的启动。

·当吸入管路没有安装底阀或单向阀时,每次启动都不得不再次灌泵。

·确保泵工作在它的性能参数范围之内,电流不超过电机铭牌所示。否则,调整出口闸阀的开度或在装有压力开关的系统中调整压力设定值。



注意：千万不能在未灌泵而导致完全打开的出水口不出水的状态下长时间工作,如果未灌泵必须在5分钟内停止泵的运行并打开加水堵加水。

如果必要的话,请在每次启动泵之前重复灌泵操作。

## 7.5. 泵的停车



当存在故障时必须关闭设备



本产品设计为连续工作，当希望断开本产品时可断开供电源停机(见章节6.5 电气连接)

## 8. 维修

任何维修操作前都应该先断开电源，必要时可由电工或专业技术人员操作

在带电情况下的任何类似清洁或维修的操作都可能对人身造成严重伤害



如果电源电缆出现损坏，必须由厂商、厂商代理或相同资质的人员进行更换。



突发的维修或需要部分拆解零件的维修，都必须由能看懂结构图的专业人员来操作



建议记录所有的维修过程，在维修期间特别小心注意不要带入任何外部细小异物，这会对产品的造成损害



不要在无防护措施的情况下用手直接操作，应带防水防割的手套进行过滤器的拆解清洁或其他维修工作



维修期间无关人员禁止入内

本操作手册中没有介绍的维修工作只能由CALPEDA授权的特别人员来完成  
有关产品使用和维修的更多信息请联系CALPEDA S.P.A.

## 8.1. 日常维护



每次维修工作前都应先断开电源并确保设备不会意外接通运转



对于水中含有的氯化物（氯气，海水）在不流动时增加了其腐蚀性（其PH值会随着温度的升高而降低）。在这种情况下，如果水泵长期不用，必需彻底排空并保持干燥。



建议如果临时运转过较脏的介质，应使用清水短时间运转以排出淤积沉淀物。



在泵长期不使用的情况下，如有结冰的可能，则应彻底排放掉液体(章13,图.5).

在再次启动泵-电机机组前，一定检查轴是否被卡住，并往泵内注水。

## 8.2. 系统的分解

分解前，关闭进出口隔栅。

## 8.3. 泵的拆解



关闭进出口阀门，拆卸水泵前排空水泵（图5）  
拆卸及回装详见构造图中的剖面图

## 9. 处理



产品的最终处理应由专业公司操作  
确保专业公司是按照材料分类方式处理  
按照当地的法规和有关环境保护的国际准则处理

## 10. 备件

### 10.1. 订购备件

订购备件时请根据剖面图提供备件的名称和位置编号及泵铭牌上的数据（型号、参数和序列号）  
备件需求请电话、传真、邮件给CALPEDA S.P.A

### 11. 部件名称

名称
14.00 泵壳
14.04 带垫片的注水堵
14.06 O形圈
14.12 带垫片的放水堵
14.16 O形圈
14.20 O型圈
14.24 螺丝
16.00 入口壳体
16.14 柱塞阀
15.15 弹簧
16.16 O型圈
16.17 单流阀
20.00 出水口壳体
22.12 螺钉
22.16 螺母
25.01 首级导叶
25.02 各级导叶
25.05 末级导叶
25.10 代替叶轮的调整垫片
25.11 首级垫圈
28.00 叶轮
28.04 叶轮锁母
28.08 垫片
34.00 泵壳盖
36.00 机械密封
36.51 两半保持圈
46.00 挡水圈
64.15 内部隔套
70.00 泵侧电机盖
73.00 泵侧轴承
76.00 带绕组的
76.04 电缆密
76.16 支脚
76.54 接线盒
78.00 轴与转子
81.00 风扇侧轴
82.00 风扇侧轴
82.04 补偿弹
88.00 电机风
90.00 风扇罩
90.04 螺丝
92.00 连接螺栓
94.00 电容
94.02 电容套
98.00 接线盒
98.08 垫圈
99.00:电机总成

保留更改权利

## 12. 常见故障和解决方法

OFF



警告: 任何操作之前均应断开电源。  
决不允许泵组于转,即使是短时间的。  
严格按照使用说明书操作,如有必要请联系授权服务中心。

故障现象	故障的可能原因	解决办法
1) 电机不启动	1a) 电源供应不匹配 1b) 接线错误 1c) 电机过载保护装置动作 1d) 保险丝故障 1e) 轴卡死 1f) 若上述原因已检查确认,那可能是电机故障	1a) 检查供电电源的电压、频率是否符合电机铭牌所示 1b) 正确连接主电源线到接线端子,检查热过载保护装置的正确性是否正确(见电机铭牌上的数据)务必保证电机保险丝安装正确。 1c) 检查供电电源并确保泵轴可自如的转动。检查热过载保护是否被正确的设定(看电机铭牌数据) 1d) 更换保险丝,检查主电源重复a)和c)的步骤 1e) 见2) 泵卡阻 1f) 向授权的服务中心申请维修或更换电机
2) 泵卡阻	2a) 设备长时间的停放使泵内部生锈 2b) 泵转子内部有固体异物 2c) 轴承损坏	2a) 从泵轴或联轴器处直接盘泵(盘泵前首先要切断电源),或者联系授权服务中心 2b) 如果可能,请拆除泵壳并除去内部转子中的异物。如有需要请联系授权服务中心 2c) 如果轴承受损请更换或联系授权服务中心
3) 泵工作但不出水	3a) 可能入口管路连接处漏气、或是排/灌水堵处、入口管路垫片处 3b) 底阀堵塞或吸入管没有完全浸入在液体中 3c) 入口过滤器堵塞	3a) 检查看哪里没拧紧连接到位并正确连接 3b) 清洁或更换底阀并使用适合于工况的进口管路 3c) 清洁过滤器,或更换。同时参见2a)
4) 流量不足	4a) 管路及其附件直径过小导致水头损失过大 4b) 流道内有沉积物或固体异物 4c) 转子腐蚀损坏 4d) 转子和泵壳磨损 4e) 泵送介质粘度过高(不同于水) 4f) 旋转方向错误 4g) 吸程超过了泵的自吸能力 4h) 入口管路过长	4a) 请使用符合工况的管路及其附件 4b) 清洁转子并安装入口过滤器以防止外部固体异物进入 4c) 更换转子,如果需要请联系授权服务中心 4d) 更换转子和泵壳 4e) 泵不适用 4f) 在控制柜内或电机接线盒内对调任意两根接线 4g) 请尝试部分关闭供水阀门和/或降低泵的安装高度,液体将被吸入。 4h) 使泵尽量靠近入口水箱以便缩短进口管路。如有必要应选用大口径进水管。
5) 泵的噪音和震动	5a) 转子不平衡 5b) 轴承磨损 5c) 泵和管路未固定到位 5d) 输送管路直径过小 5e) 发生汽蚀 5f) 供电电源不平衡 5g) 泵与电机不同心	5a) 检查转子中是否有固体异物 5b) 更换轴承 5c) 将进水管路固定到位 5d) 使用更大直径的管路或降低泵的流量 5e) 通过调节供水阀门降低流量,并且/或 使用内径更大的管路。参考4g) 5f) 检查供电电压是否正确 5g) 再次校正同心度
6) 机封漏水	6a) 机封于转或粘连 6b) 泵送介质中有磨蚀性物质导致机封刮损 6c) 机封不适用于当前工况 6d) 在第一次启动或灌泵时的轻微波滴漏	对于6a), 6b) 和 6c) 的情况,更换机封,如果需要请联系授权服务中心 6a) 务必保证泵壳体内(如为非自吸泵,吸入管道内)充满液体,且空气已被完全排出,参见5e)。 6b) 安装入口过滤器,使用与泵送介质特点匹配的机封 6c) 选用适用于此工况的机封 6d) 待泵运行一会儿机封自行调整,如果问题依旧请参考6a), 6b), 6c)或联系授权服务中心。

中文

13. Esempi di installazione  
 Installation examples  
 Einbaubeispiele  
 Exemples d'installation  
 Ejemplos de instalaciones  
 Installationsexempel  
 Installatievoorbeelden  
 Παραδείγματα εγκαταστάσεων  
 Примеры установки  
 安装示意图

Regolatore automatico  
 Automatic regulator  
 Schaitautomat  
 Regulateur automatique  
 Regulador automático  
 Automatisk regulator  
 Automatische schakelaar  
 Αυτόματος ρυθμιστής  
 Электронный регулятор  
 自动压力调节器

IDROMAT

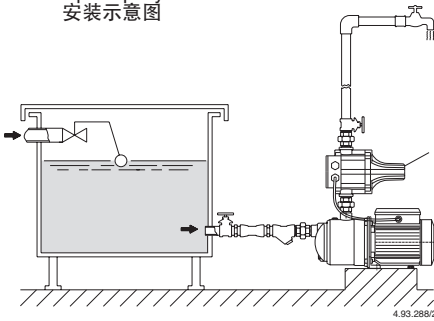

Fig. 1

Funzionamento sotto battente  
 Positive suction head operation  
 Zulaufbetrieb  
 Fonctionnement en charge  
 Funcionamiento bajo carga  
 Tillrinning sugsidan  
 Toeloopsituatie  
 Θέση λειτουργίας με θετική αναρρόφηση  
 Работа под гидравлическим напором  
 正压上水头的操作

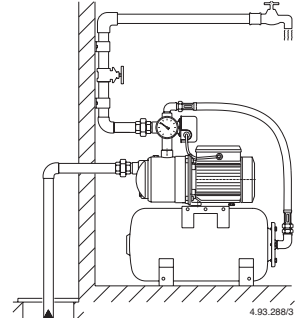

Fig. 2

Funzionamento in aspirazione  
 Suction lift operation  
 Saugbetrieb  
 Fonctionnement en aspiration  
 Funcionamiento en aspiración  
 Sugande funkcion  
 Zuigsituatie  
 Θέση λειτουργίας με κάθστη αναρρόφηση  
 Работа выше уровня жидкости  
 负压水头工作

中文

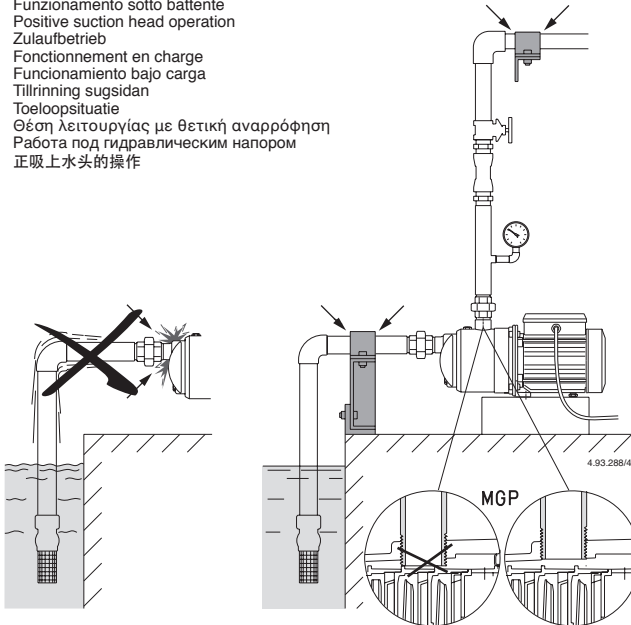

Fig. 3

Sostegni ed ancoraggi delle tubazioni  
 Supports and clamps for pipelines  
 Stützen und Verankerungen der Rohrleitungen  
 Soutien et ancrage des tuyaux  
 Sostén y anclaje de la instalación  
 Konsoll samt klämmor för rör  
 Steunen voor leidingen  
 Υποστήριξη και σφίξιμο σωληνώσεων  
 Епоры и крепления труб  
 管路的支撑及夹具

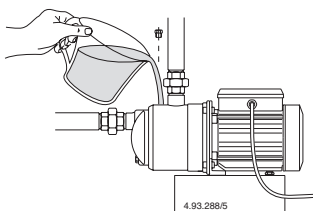

Fig. 4

Riempimento  
 Filling  
 Auffüllung  
 Remplissage  
 Llenado  
 Fyllning  
 Vullen  
 Γέμισμα  
 Наполнение  
 灌泵

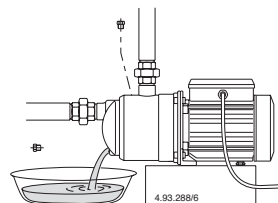
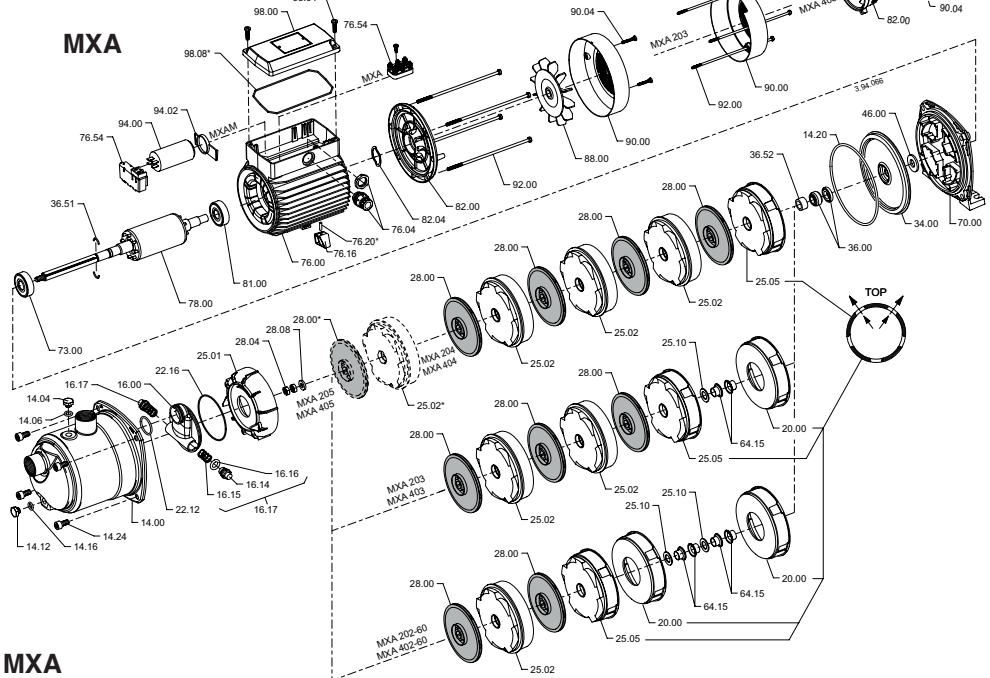

Fig. 5

Scarico  
 Draining  
 Entleerung  
 Vidange  
 Vaciado  
 Avtapping  
 Aftappen  
 Αποστράγγιση  
 Слив  
 排空



13.1. Disegno per lo smontaggio ed il rimontaggio  
 Drawing for dismantling and assembly  
 Zeichnung für Demontage und Montage  
 Dessin pour démontage et montage  
 Dibujo para desmontaje y montaje  
 Ritning för demontering och monterning  
 Onderdelentekening  
 Чертеж для демонтажа и сборки  
 组装与分解图



**MXA**

Capacità di autoadescamento  
 Self-priming capability  
 Selbstansaug-Fähigkeit  
 Capacité d'autoamorçage  
 Capacidad de autoaspiración  
 Själv-evakuerande förmåga  
 Zelfaanzuigend vermogen  
 Αναρροφητική ικανότητα  
 Способность самовсасывания  
 自吸能力

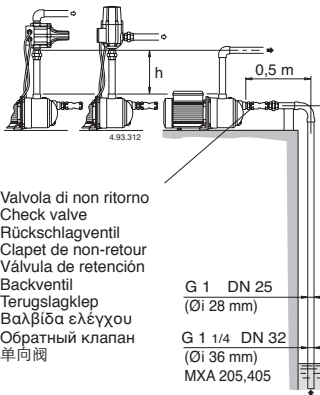

Valvola di non ritorno  
 Check valve  
 Rückschlagventil  
 Clapet de non-retour  
 Válvula de retención  
 Backventil  
 Terugslagklep  
 Βαλβίδα ελέγχου  
 Обратный клапан  
 单向阀

Hs (m) ≤	h (mm)				
	203	204	205	403	404 405
2	100	100	500	100	500
4	200	200	500	450	500
6	450	450	500	600	600
8	600	600	600	600	600

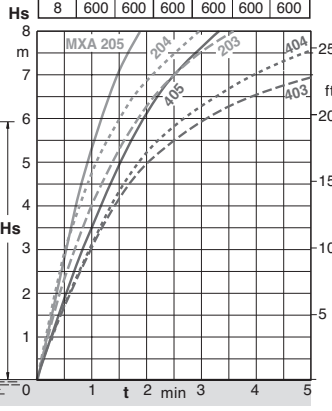

H<sub>2</sub>O, T = 20°C,  
 Pa = 1000 hPa (mbar)  
 50 Hz (n = 2800 1/min),  
 For 60 Hz see the data sheet.

Hs (m)  
 Altezza di aspirazione  
 Suction lift  
 Saughöhe  
 Hauteur d'aspiration  
 Altura de aspiración  
 Sughöjd  
 Zuighoogte  
 Βόθος αναρρόφησης  
 Высота всасывания  
 吸程

t (min)  
 Tempo di autoadescamento  
 Self-priming time  
 Selbstansaugezeit  
 Temps d'autoamorçage  
 Tiempo de autoaspiración  
 Själv-evakuerande tid  
 Zelfaanzuigtijd  
 Χρόνος αναρρόφησης  
 Время самовсасывания  
 自吸时间

13.1. Disegno per lo smontaggio ed il rimontaggio  
 Drawing for dismantling and assembly  
 Zeichnung für Demontage und Montage  
 Dessin pour démontage et montage  
 Dibujo para desmontaje y montaje  
 Ritning för demontering och montering  
 Onderdelentekening  
 Чертеж для демонтажа и сборки  
 组装与分解图

**MXP, MGP**

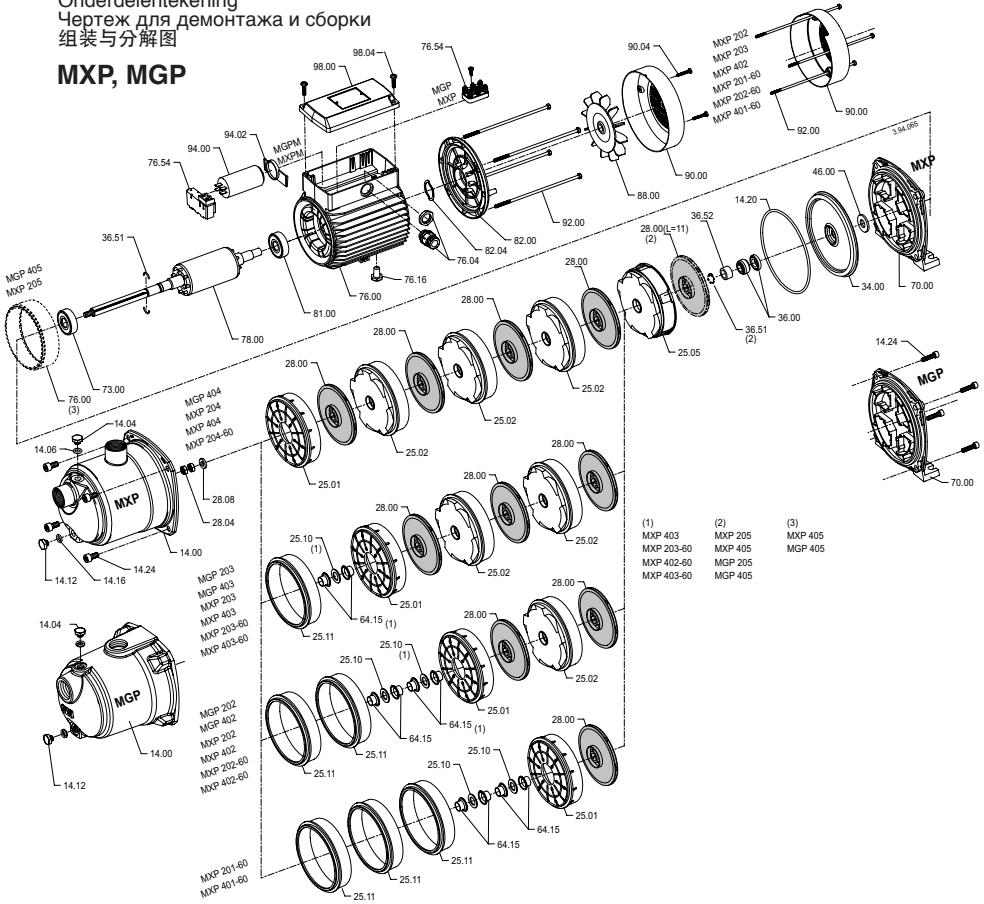

13.2. Sezione minima dei conduttori  
 Minimum cross-sectional area of conductors

Tab. 1 TAB 1IEC 60335-1

Corrente nominale dell'apparecchio Rated current of appliance A	Sezione nominale Nominal cross-sectional area mm <sup>2</sup>
>0,2 + ≤3	0,5 <sup>a</sup>
>3 + ≤6	0,75
>6 + ≤10	1,0
>10 + ≤16	1,5
>16 + ≤25	2,5
>25 + ≤32	4
>32 + ≤40	6
>40 + ≤63	10

<sup>a</sup> Questi cavi possono essere usati solo se la loro lunghezza non supera 2 m tra il punto in cui il cavo o la sua protezione entra nell'apparecchio e l'entrata nella spina.

These cords may only be used if their length does not exceed 2 m between the point where the cord or cord guard enters the appliance and the entry to the plug.

**IT****DICHIARAZIONE DI CONFORMITÀ**

Noi CALPEDA S.p.A. dichiariamo sotto la nostra esclusiva responsabilità che le Pompe MXA, MXAM, MXP, MXPM, MGP, MGPM, tipo e numero di serie riportati in targa, sono conformi a quanto prescritto dalle Direttive 2006/42/CE, 2009/125/CE, 2014/30/EU, 2014/35/EU e dalle relative norme armonizzate. Regolamento della Commissione N. 640/2009.

**GB****DECLARATION OF CONFORMITY**

We CALPEDA S.p.A. declare that our Pumps MXA, MXAM, MXP, MXPM, MGP, MGPM, with pump type and serial number as shown on the name plate, are constructed in accordance with Directives 2006/42/EC, 2009/125/EC, 2014/30/EU, 2014/35/EU and assume full responsibility for conformity with the standards laid down therein. Commission Regulation No. 640/2009.

**D****KONFORMITÄTSEKTLÄRUNG**

Wir, das Unternehmen CALPEDA S.p.A., erklären hiermit verbindlich, daß die Pumpen MXA, MXAM, MXP, MXPM, MGP, MGPM, Typbezeichnung und Fabrik-Nr. nach Leistungsschild den EG-Vorschriften 2006/42/EG, 2009/125/EG, 2014/30/EU, 2014/35/EU entsprechen. ErP-Richtlinie N. 640/2009.

**F****DECLARATION DE CONFORMITE**

Nous, CALPEDA S.p.A., déclarons que les Pompes MXA, MXAM, MXP, MXPM, MGP, MGPM, modèle et numero de série marqués sur la plaque signalétique sont conformes aux Directives 2006/42/CE, 2009/125/CE, 2014/30/EU, 2014/35/EU. Règlement de la Commission N° 640/2009.

**E****DECLARACION DE CONFORMIDAD**

En CALPEDA S.p.A. declaramos bajo nuestra exclusiva responsabilidad que las Bombas MXA, MXAM, MXP, MXPM, MGP, MGPM, modelo y numero de serie marcados en la placa de características son conformes a las disposiciones de las Directivas 2006/42/CE, 2009/125/CE, 2014/30/EU, 2014/35/EU. Reglamento de la Comisión n.º 640/2009.

**DK****OVERENSSTEMMELSEERKLÆRING**

Vi CALPEDA S.p.A. erklærer hermed at vore pumper MXA, MXAM, MXP, MXPM, MGP, MGPM, pumpe type og serie nummer vist på typeskiltet er fremstillet i overensstemmelse med bestemmelserne i Direktiv 2006/42/EC, 2009/125/EC, 2014/30/EU, 2014/35/EU og er i overensstemmelse med de heri indeholdte standarder. Kommissionens forordning nr. 640/2009.

**NL****CONFORMITEITSVERKLARING**

Wij CALPEDA S.p.A. verklaren hiermede dat onze pompen MXA, MXAM, MXP, MXPM, MGP, MGPM, pomptype en serienummer zoals vermeld op de typeplaat aan de EG-voorschriften 2006/42/EU, 2009/125/EU, 2014/30/EU, 2014/35/EU voldoen. Verordening van de commissie nr. 640/2009.

**SF****VAKUUTUS**

Me CALPEDA S.p.A. vakuutamme että pumpppumme MXA, MXAM, MXP, MXPM, MGP, MGPM, malli ja valmistusnumero tyypikilvistä, ovat valmistettu 2006/42/EU, 2009/125/EU, 2014/30/EU, 2014/35/EU direktiivien mukaisesti ja CALPEDA ottaa täyden vastuun siitä, että tuotteet vastaavat näitä standardeja. Komission asetus (EY) N:o 640/2009.

**S****EU NORM CERTIFIKAT**

CALPEDA S.p.A. intygar att pumpar MXA, MXAM, MXP, MXPM, MGP, MGPM, pumptyp och serienummer, visade på namnplåten är konstruerade enligt direktiv 2006/42/EC, 2009/125/EC, 2014/30/EU, 2014/35/EU. Calpeda åtar sig fullt ansvar för överensstämmelse med standard som fastställts i dessa avtal. Kommissionens förordning nr 640/2009.

**GR****ΔΗΛΩΣΗ ΣΥΜΦΩΝΙΑΣ**

Εμείς ως CALPEDA S.p.A. δηλώνουμε ότι οι αντλίες μας αυτές MXA, MXAM, MXP, MXPM, MGP, MGPM, με τύπο και αριθμό σειράς κατασκευής όπου αναγράφεται στην πινακίδα της αντλίας, κατασκευάζονται σύμφωνα με τις οδηγίες 22006/42/EOK, 2009/125/EOK, 2014/30/EU, 2014/35/EU και αναλαμβάνουμε πλήρη υπευθυνότητα για συμφωνία (συμμόρφωση), με τα στάνταρς των προδιαγραφών αυτών. Κανονισμός Αρ. 640/2009 της Επιτροπής.

**TR****UYGUNLUK BEYANI**

Bizler CALPEDA S.p.A. firması olarak MXA, MXAM, MXP, MXPM, MGP, MGPM, Pompalarımızın, 2006/42/EC, 2009/125/EC, 2014/30/EU, 2014/35/EU, direktiflerine uygun olarak imal edildiklerini beyan eder ve bu standartlara uygunluk"ına dair tüm sorumluluk"ü üstleniriz. 640/2009 sayılı Komisyon Yönetmeliği.

**RU****ДЕКЛАРАЦИЯ СООТВЕТСТВИЯ**

Компания "Calpeda S.p.A." заявляет с полной ответственностью, что насосы серий MXA, MXAM, MXP, MXPM, MGP, MGPM, тип и серийный номер которых указывается на заводской табличке соответствуют требованиям нормативов 2006/42/CE, 2009/125/CE, 2014/30/EU, 2014/35/EU. Постановление Комиссии № 640/2009.

**中文****声明**

我们科沛达泵业有限公司声明我们制造的 MXA, MXAM, MXP, MXPM, MGP, MGPM. (在标签上的泵型号和序列号)均符合以下标准的相应目录:2006/42/EC,2009/125/EC,2014/30/EU,2014/35/EU.本公司遵循其中的标准并承担相应的责任.委员会条例 No.640/2009

Montorso Vicentino, 07.2017

Il Presidente  
Marco Mettifogo



Calpeda s.p.a. - Via Roggia di Mezzo, 39 - 36050 Montorso Vicentino - Vicenza / Italia  
Tel. +39 0444 476476 - Fax +39 0444 476477 - E.mail: info@calpeda.it www.calpeda.com